

Data Sheet



Article number: 021500700108

Description: Sealing Clamp S 108 W5

Measures

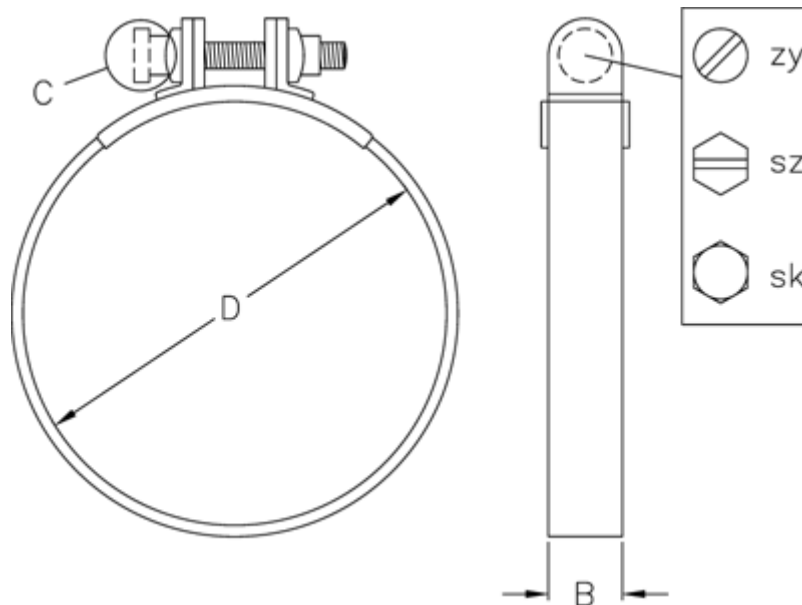

C (screw type) = SZ
Diameter D = 108
Width B = 20